

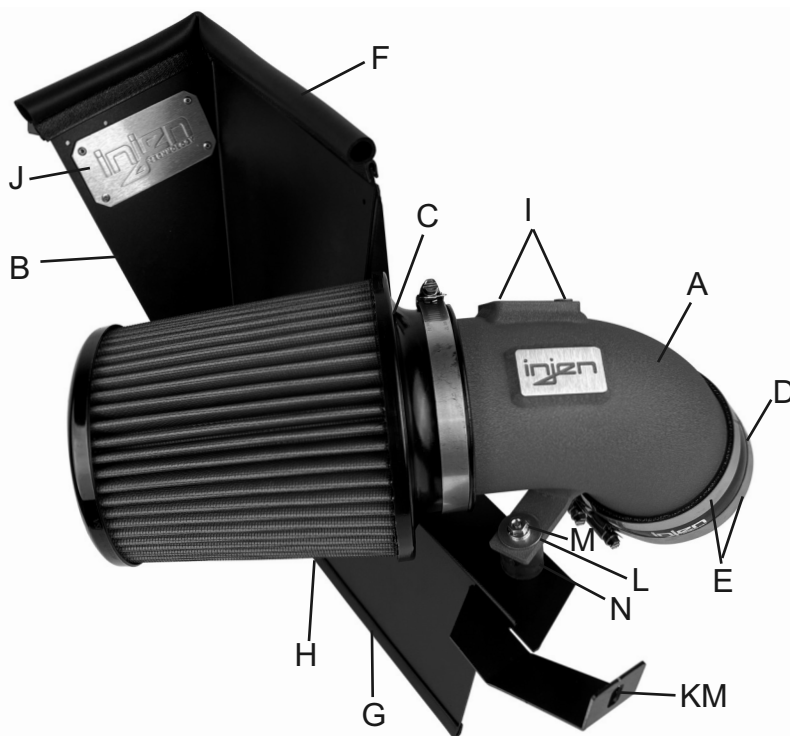

Vehicle Application:
Make: Toyota
Model: Supra A90
(Not CARB approved)
Year: 2020
Engine: 3.0L L6 Turbo



Item	QTY.	P/N	Discription
A	1	W-SP2300	Intake Tube
B	1	X-11171	Heat shield
C	1	X-1026-BB	4" Dry filter (Blue Media)
D	1	X-3129	4" straight hose
E	2	X-4006	#64 clamps
F	1	X-6058	Rubber trim @ 14" L
G	1	X-6023	Vinyl trim @ 2"L
H	1	X-6023	Vinyl trim @ 8" L
I	2	X-6047	M4 screws
J	1	X-11097	injen aluminum badge
K	1	X-6005	M6 x 16 hex screw
L	1	X-6011	Fender washer
M	2	X-6002	M6 nut
N	1	X-6020	M6 vibramount

TOOLS REQUIRED

- 10mm Ratchet & Socket
- 8mm nut drive
- Allen key
- Flat Blade Screwdriver
- Phillips Screwdriver

WARNING: FAILURE TO FOLLOW INSTALLATION INSTRUCTIONS AND NOT USING THE PROVIDED HARDWARE MAY DAMAGE THE INTAKE SYSTEM, ENGINE AND COMPONENTS!!!
***Do not attempt to install the intake system while the engine is hot.**
 Severe burn could result from touching hot engine components!

Report any defective or missing parts to the authorized Injen dealer you purchased this product from. Before installing any parts of this system, please read the instructions thoroughly. If you have any questions regarding installation, please contact your Injen Technology dealer. Installation DOES require some mechanical skills. A qualified mechanic is always recommended.

A Limited Lifetime Warranty to the original purchaser against defects in material and workmanship on all Injen intake systems excluding the filter element. Any and all warranty coverage is limited to the repair or replacement of the defective part only, at Injen Technology's discretion. The warranty does not cover incidental or consequential damages, nor does it cover the cost of installation or removal of the defective part or its replacement. Proof of purchase is required.

Instruction Manual P/N:SP2300

NOTE: This intake kit may not work on vehicles with the following aftermarket modifications.

- Aftermarket Intercooler piping
- Aftermarket intercooler
- Turbo upgrade
- Modified body panels
- Suspension & Chassis modifications

Injen intake systems are street legal in most states unless the state is adopting to California Emissions standards. States that have adopted California emission standards include: Arizona, California, Connecticut, District of Columbia, Maine, Maryland, Massachusetts, New Jersey, New Mexico, New York, Oregon, Pennsylvania, Rhode Island, Vermont, and Washington. These states will require an California Air Resource Board Executive Order Number (CARB E.O.) for the legal use of an Injen intake system in your vehicle for use on public roads or highways. These vehicle will be considered "Legal in California only for racing vehicles competition use only, which may never be used upon a public street or highway. **Please keep your factory air box assembly for any future use.**



The SuperNano-Web filter media is a dry synthetic media that outperforms the competition. The media itself is a proprietary base blend of synthetics and cellulose. Cellulose fibers are larger than synthetic fibers, and have larger spaces between the fibers, causing contaminants to load in the depth of the media and plug the airflow path. This creates higher restriction levels and less capacity. The synthetic fibers in the SuperNano-Web media are submicron in diameter and have small interior fiber spaces, which result in more contaminants being captured on the surface of the media. This can help keep restriction levels low as the filter loads with dirt and containments

If you look at the picture to the left, you can see the Nano-fiber web on top of our base media. That web, or SuperNano-Web as we like to call it, helps trap smaller particles and protect your engine.

To Clean your filter:

Carefully remove the filter from the housing. Once removed, wipe down the housing using a clean shop towel, being careful not to knock any dirt and/or debris in the air inlet. Your filters can be cleaned by carefully vacuuming the filter media from the dirty side, or by holding the filter with one hand and carefully blowing the filter media at a 45-degree angle from the clean side using low-pressure shop air (15-20 lbs. psi).

****IT IS IMPORTANT TO NOT USE ANY CLEANERS ON THE SUPERNANO-WEB MEDIA OR APPLY ANY OIL!!!***

NOTE: DISCONNECT BATTERY BEFORE INSTALLATION!!!

Instruction Manual P/N:SP2300



1. Stock intake system shown.

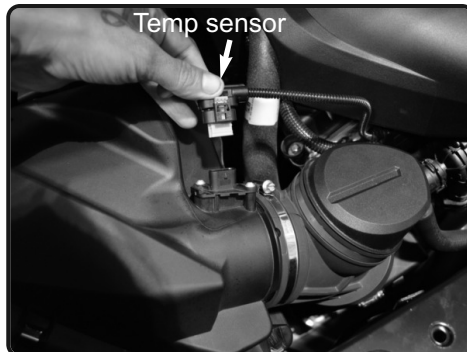

2. Disconnect the Temp sensor harness and pull harness cable from the air box.



3. Loosen the clamp on the air box using 6mm nut driver. Pull back the intake tube from the air box.



4. Carefully lift up and remove the airbox from the vehicle. **Note: Next photo intake tube was removed for easier look at intake tube and for photos.**



5. With a flat head screw driver, pull back the lock clip on the turbo. Slide out intake tube from turbo. Disconnect the crank case line on the intake tube by depressing clip. With flat head screwdriver, break the security clamp loose.



6. Remove the security clamp from intake tube.



7. Remove the intake tube from the hard plastic intake tube. **Make sure the Lock clip is seated correctly in the intake tube to allow the tube to secured properly to turbo.**

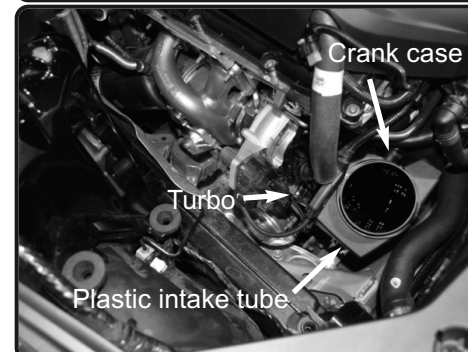

8. Re-install the plastic intake tube into the vehicle. Re-connect Crank case line. Make sure you hear a click, tug on tube to make sure the tube is secured to turbo and will not come off.



9. Install the provided Rubber trim to the top of the heatshield. Notch corner with pliers/cutters for easier installation.

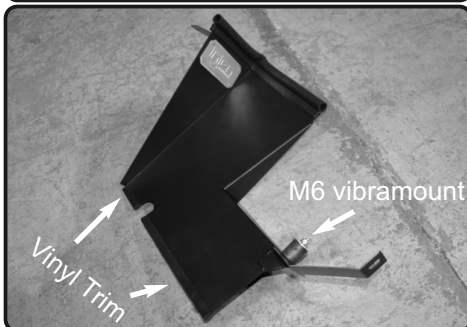

10. Install the provided Vinyl trim pieces to the bottom of the heatshield. Install the M6 vibramount to the Thredded insert on heatshield.

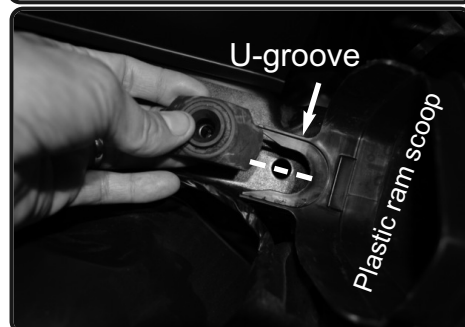

11. Remove the Air box grommet located on the frame in front of Plastic ram scoop. Heat shield will seat inside this plastic U-groove.

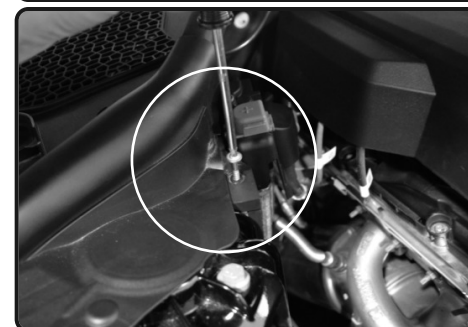

12. Loosen the T30 torx screw located on the frame in front of Plastic ram scoop. Save bolt for later install.

Instruction Manual P/N:SP2300



13. Install the heatshield into vehicle. Front tab will fit on radiator support.

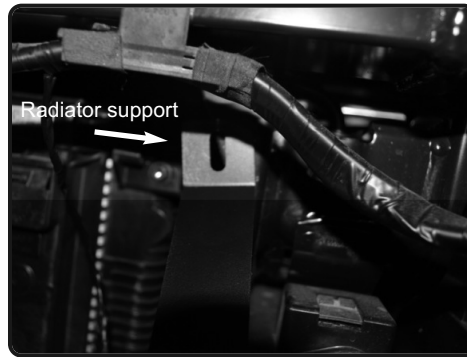

14. Make sure the heatshield is flat on frame. Locate the hole on the radiator support.

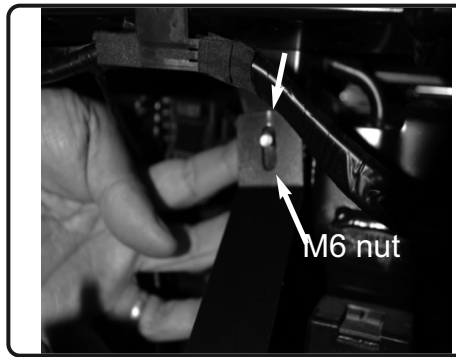

15. Secure the heatshield tab to the radiator support using M6 screw and M6 nut. Secure and tighten using 10mm wrench or ratchet.



16. Secure the tab on heatshield using the OEM torx screw. Secure and tighten.



17. Complete heatshield assembly installed. Tighten all screws and secure.

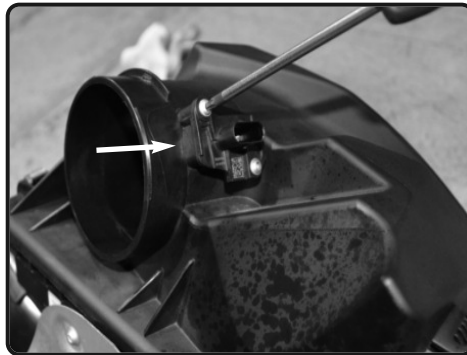

18. Loosen the 2 screws holding in the temp sensor using T25 torx bit and remove from air box.



19. Re-install the temp sensor into the new Injen intake tube and secure using the provided M4 button head screws.



20. Install the provided 4" straight hose with clamps to the plastic intake tube. Tighten clamp on the plastic tube only.



21. Install the intake tube into the vehicle and position to the straight hose and bracket to the vibramount.

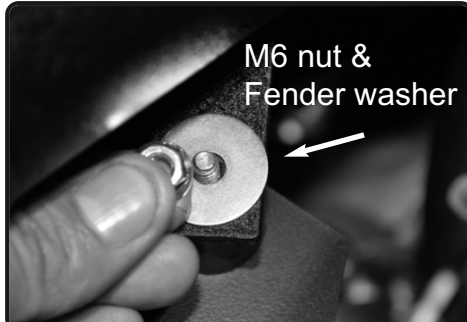

22. Secure the bracket on intake tube using provided M6 nut and fender washer. Tighten using 10mm socket or wrench.



23. Tighten the clamp on the intake tube using 8mm nut driver.



24. Re-connect the temp harness.



25. Install the air filter to the intake tube.



26. Secure and tighten using 8mm nut driver. Re-adjust if you need to and re-tighten intake tube.



Congratulations! You have just completed the installation of this intake system. Periodically, check the alignment of the intake, normal wear and tear can cause nuts and bolts to come loose. **Note: Check clearance and adjust if needed! Failure to check the alignment and adjust the intake can cause damage that will void the warranty. Injen Technology is not responsible for any damages caused by/from improper installation.**

Test Drive:

1. With the transmission in neutral or park and the parking brake engaged, start the engine. Listen for air leaks or odd noises. If air leaks are detected, secure hoses and connections. For any odd noises, inspect entire system for cause and adjust intake as needed. The Injen intake will function identically to the factory system but will be louder and more powerful.
2. Perform a road test. Listen for odd noises or rattles and fix as necessary.
3. If there are no issues, continue to enjoy your added performance from the Injen performance Intake kit.
4. Injen Technology recommends you periodically check clearance and adjust if needed! Failure to check the alignment and adjust the intake can cause damage that will void the warranty. Injen Technology is not responsible for any damages caused by/from improper installation.

1. Upon completion of the installation, reconnect the negative battery terminal before you start the engine.
2. Align the entire intake system for the best possible fit. Once the intake has been properly fitted continue to tighten all nuts, bolts and clamps.
3. Periodically, recheck the alignment of the intake system and make sure there is proper clearance around and along the length of the intake. Failure to follow proper maintenance procedures may cause damage to the intake and will void the warranty.
4. Start the engine and listen carefully for any odd noises, rattles and/or air leaks prior to taking it for a test drive. If any problems arise go back and check the vacuum lines, hoses and clamps that maybe causing leaks or rattles and correct the problem.
5. Check the filter for excessive dirt build up. Clean or replace the filter with an original Injen filter (can be bought on-line at "injenonline.com"). Congratulations! You have just completed the installation of the best intake system sold on the market. Enjoy the added power and performance of your new intake system.