



Part number SP1986
2003-06 Nissan 350Z
3.5L, V6

- 1- 3 piece intake system (CV)
- 1- 3 1/2" Injen filter (#1015)
- 1- Secondary silicone intake tract (#3052)
- 1- 3 1/8" Straight hose (#3054)
- 3- Power-bands (.048)(.362) (#4004)
- 1- Power-bands (.056)(.412) (#4005)
- 1- M6 flange nut (#6002)
- 1- Fender washer (#6010)
- 1- M6 vibra-mount (#6020)
- 1- 5 Page instructions

Note: This intake system was specifically designed and tested with the Injen filter element. All parts and accessories are sold on-line at:
"injenonline.com"

Congratulations! You have just purchased the best engineered, dyno-proven cold air intake system available.

Please check the contents of this box immediately.

Report any defective or missing parts to the Authorized Injen Technology dealer you purchased this product from. Before installing any parts of this system, please read the instructions thoroughly. If you have any questions regarding installation please contact the dealer you purchased this product from.

Installation DOES require some mechanical skills. A qualified mechanic is always recommended.

*Do not attempt to install the intake system while the engine is hot. The installation may require removal of radiator fluid line that may be hot.

Injen Technology offers a limited lifetime warranty to the original purchaser against defects in materials and workmanship. Warranty claims must be handled through the dealer from which the item was purchased.

Injen Technology 244 Pioneer Place Pomona, CA 91768 USA

Please check the contents of this box immediately.

Note: This intake system was Dyno-tested with an Injen filter and Injen parts the use of any other filter or part will void the warranty and CARB exemption number.

Parts and accessories are available on line at "Injenonline.com"

Note: The installation of this cold air intake does require mechanical skills. Removal of the front bumper requires loosening and removing several plastic plugs and screws that may be difficult. It is recommended that this system be installed by a professional mechanic. Be sure to disconnect the negative terminal before proceeding.

Congratulations! You have just purchased the worlds first tuned intake system.

MR Technology, Leading the way!



Fig 1

Hydro-shield used for this application
X-1034





Fig 2
Loosen two nuts and remove the plastic intake manifold cover before installing the intake.



Fig 3
The front air scoop is removed in order to make room for the silicone intake hose.



Fig 4
Remove the MAF sensor from the sensor housing. The sensor housing will no longer be used in this application.



Fig 5
(A) The entire air intake box, duct and sensor housing is removed in one piece. (B) Before removing the air intake box from the engine compartment, disconnect the breather line connected to the box and crankcase.



Fig 6
Prior to installing the cold air intake the front bumper will need to be removed. See next page diagram (A) for instructions.



Fig 7
Screw the vibra-mount into the pre-tapped mounting point of the intake manifold. Screw the vibra-mount in until it is firmly in place.



Fig 8
Press the 3/8" straight hose over the throttle body and use two medium .362 power-bands, tighten the clamp on the throttle body at this point.

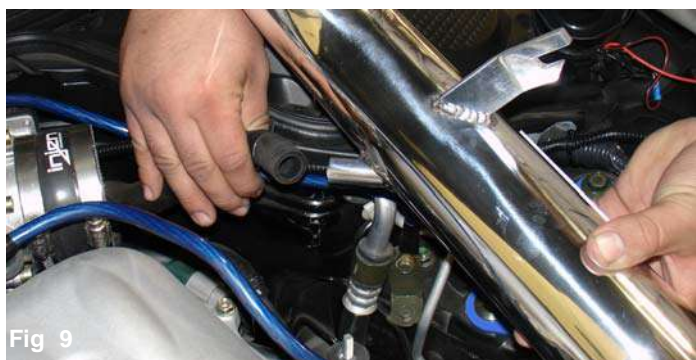

Fig 9
Take the primary intake and position it in place. The first step is to press the crankcase breather hose over the 5/8" port on the intake. Continue to align the entire intake by following the next steps of the instructions.

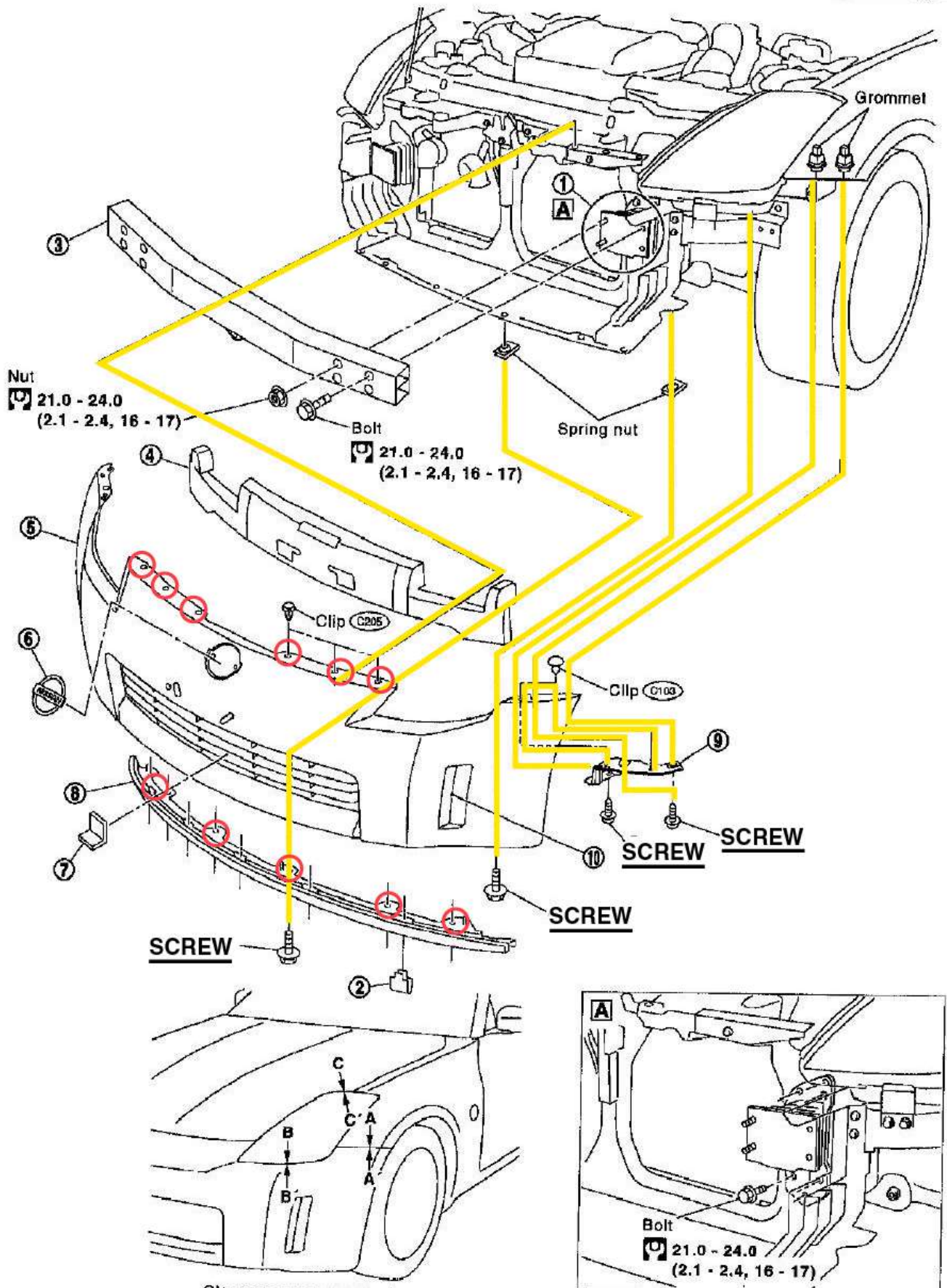



Fig 10
The crankcase breather line is attached to the intake port and the stock clamp is used to secure the line in place.

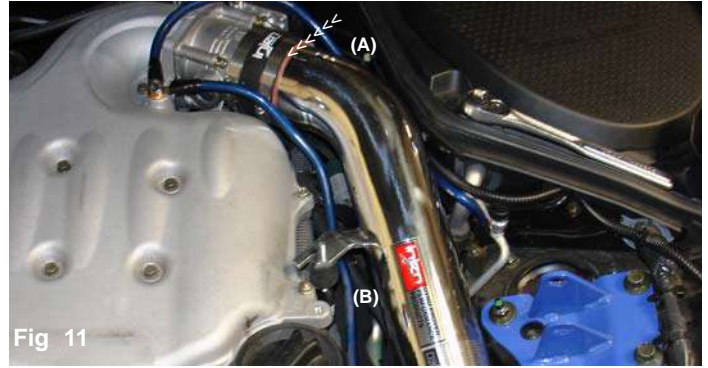

Fig 11
Press the top end of the intake into the hose on the throttle body (A) while aligning the bracket on the intake to the vibra-mount stud (B).



Fig 12
Once the intake is aligned use the m6 flange nut and fender washer to secure the intake in place.



Fig 13
Press the stock MAF sensor into the machined adapter welded to the intake and use the stock screws to secure the sensor in place.

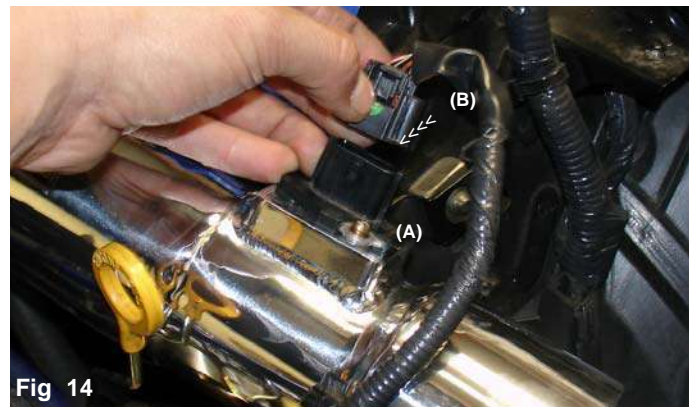

Fig 14
The two stock screws are now securing the MAF sensor to the adapter (A). The harness clip is pressed over the sensor until it snaps in place (B).



Fig 15
Once the entire intake is aligned and secured in place the intake manifold cover is re-attached.

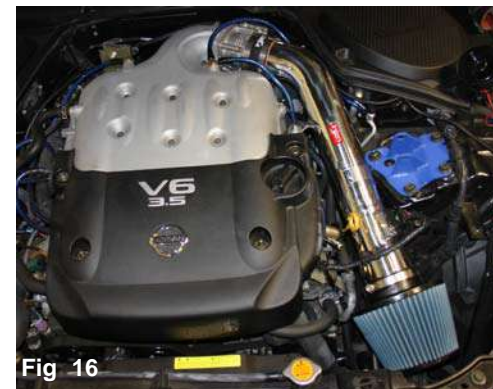

Fig 16
The cold air intake is seen in this picture used as a short ram.

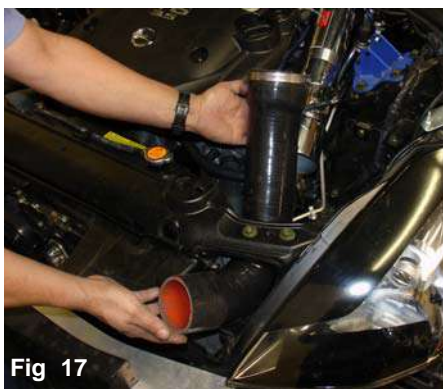

Fig 17
Slip the secondary silicone into the air scoop opening and point the front end down towards the front of the radiator.



Fig 18
The 3 1/2" top end of the hose is pressed over the primary end of the intake. Use one .412 large power-band to secure the hose in place.

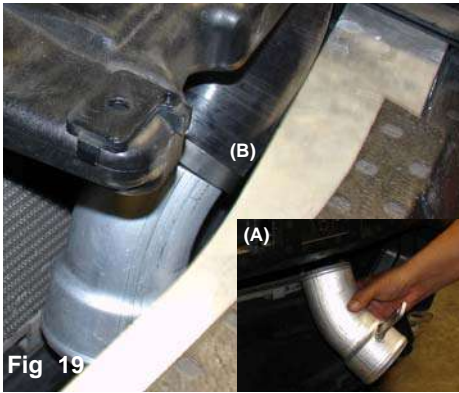

Fig 19 Take the final piece of the intake slip it through the bottom bumper(A). Slip the intake into the end of the silicone intake and use the .362 power-band to secure intake in place (B).



Fig 20 Line up the pre-tapped hole on the bumper reinforcement to the intake bracket. Use the stock plastic clip to secure the intake in place.



Fig 21 The plastic clip is shown here locating the intake to the bottom of the bumper reinforcement.



The 3/12" filter is placed over the end of the intake. The clamp on the filter neck is tightened to hold the filter in place (A).

Check the entire intake track for best possible fit. Once the intake has been cleared from any rubbing parts continue to tighten all nuts, bolts and clamps. Congratulations, You have just completed the installation of the this cold air intake (B).



(B) Fig 23

1. Once the installation is complete, reconnect the negative battery terminal before you start the engine.
2. Align the entire intake system for the best possible fit. Once the intake has been properly fitted continue to tighten all nuts, bolts and clamps.
3. Periodically, recheck the alignment of the intake system and make sure there is proper clearance around and along the length of the intake. Failure to follow proper maintenance procedures may cause damage to the intake and will void the warranty.
4. Start the engine and listen carefully for any odd noises, rattles and/or air leaks prior to taking it for a test drive. If any problems arise go back and check the vacuum lines, hoses and clamps that maybe causing leaks or rattles and correct the problem.
5. Check the filter for excessive dirt build up. Clean or replace the filter with an original Injen filter (can be bought on-line at "injenonline.com"). Congratulations! You have just completed the installation of the best intake system sold on the market. Enjoy the added power and performance of your new intake system.