

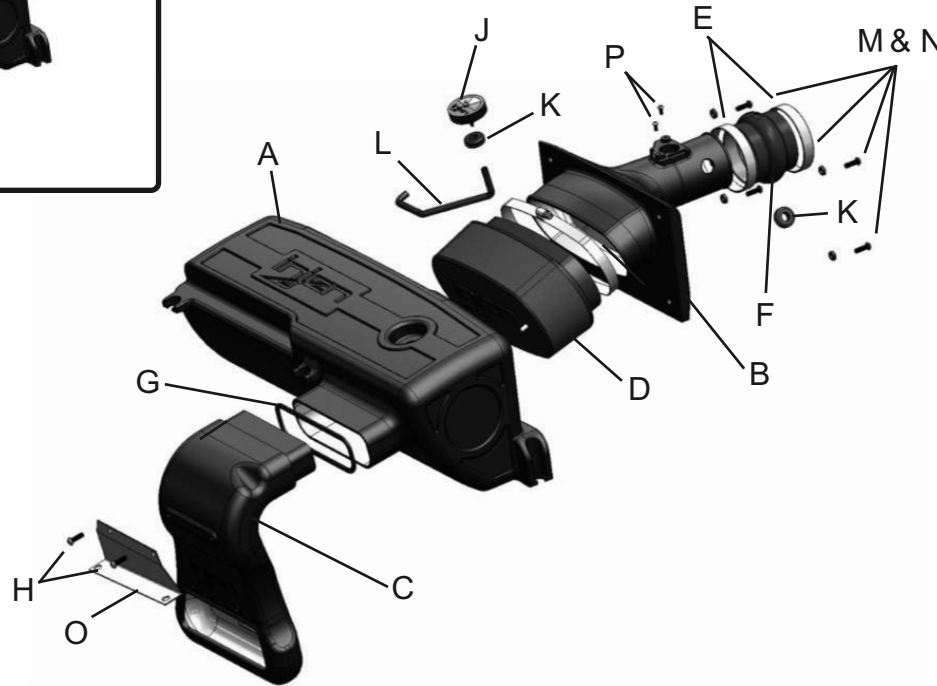

Vehicle Application:
 Make: **Scion/Subaru/Toyota**
 Model: **FRS/BRZ/86**
 Year: **2013-2017**
 Engine: **2.0L Boxer 4 Cyl.**

EXPLODED VIEW



Item	QTY.	P/N	Discription
A	1	x-15103	Air box
B	1	x-15102	Plenum
C	1	x-15104	scoop
D	1	x-1089	Air Filter
E	2	4004	#48 clamps
F	1	3209	3" hump hose
G	1	3211	Scoop Gasket
H	2	6083	M6 socket cap screws
I	1	8040	Vinyl plug
J	1	15040	Filter minder
K	2	8026	Grommet
L	1	3198	3mm hose @13" long
M	4	6100	M6x20mm phillips screw
N	4	8047	Rubberized washers
O	1	20124	Scoop Bracket
P	2	6047	M4 screws

CAUTION: Injen Technology Ram Air Intake System should be removed in any wet climate conditions. Failure to comply with the above warning may cause water to be absorbed into the engine through the filter causing serious damage to your engine. Injen Technology assumes no liability to damages to your engine due to water entering your engine through the Injen Intake system

WARNING: FAILURE TO FOLLOW INSTALLATION INSTRUCTIONS AND NOT USING THE PROVIDED HARDWARE MAY DAMAGE THE INTAKE SYSTEM, ENGINE AND COMPONENTS!!!
*Do not attempt to install the intake system while the engine is hot.
 Severe burn could result from touching hot engine components!

Report any defective or missing parts to the authorized Injen dealer you purchased this product from. Before installing any parts of this system, please read the instructions thoroughly. If you have any questions regarding installation, please contact your Injen Technology dealer. Installation DOES require some mechanical skills. A qualified mechanic is always recommended.

A Limited Lifetime Warranty to the original purchaser against defects in material and workmanship on all Injen intake systems excluding the filter element. Any and all warranty coverage is limited to the repair or replacement of the defective part only, at Injen Technology's discretion. The warranty does not cover incidental or consequential damages, nor does it cover the cost of installation or removal of the defective part or its replacement. Proof of purchase is required.

Instruction Manual P/N:EVO2000

NOTE: This intake kit may not work on vehicles with the following aftermarket modifications.

- Aftermarket Intercooler piping
- Aftermarket intercooler
- Turbo upgrade
- Modified body panels
- Suspension & Chassis modifications

The SuperNano-Web filter media is a dry synthetic media that outperforms the competition. The media itself is a proprietary base blend of synthetics and cellulose. Cellulose fibers are larger than synthetic fibers, and have larger spaces between the fibers, causing contaminants to load in the depth of the media and plug the airflow path. This creates higher restriction levels and less capacity. The synthetic fibers in the SuperNano-Web media are submicron in diameter and have small interior fiber spaces, which result in more contaminants being captured on the surface of the media. This can help keep restriction levels low as the filter loads with dirt and containments



If you look at the picture to the left, you can see the Nano-fiber web on top of our base media. That web, or Super-Nano-Web as we like to call it, helps trap smaller particles and protect your engine.

To Clean your filter:

Carefully remove the filter from the housing. Once removed, wipe down the housing using a clean shop towel, being careful not to knock any dirt and/or debris in the air inlet. Your filters can be cleaned by carefully vacuuming the filter media from the dirty side, or by holding the filter with one hand and carefully blowing the filter media at a 45-degree angle from the clean side using low-pressure shop air (15-20 lbs. psi).

****IT IS IMPORTANT TO NOT USE ANY CLEANERS ON THE SUPERNANO-WEB MEDIA OR APPLY ANY OIL!!!***

Note:

CARB E.O. 2013-2014 Models only. The C.A.R.B. Exempt sticker must be attached under the hood in a manner that is easily viewed by an emissions inspector.

NOTE: DISCONNECT BATTERY BEFORE INSTALLATION!!!

Instruction Manual P/N:EVO2000



1. Stock box shown in this picture. **DISCONNECT BATTERY BEFORE INSTALLATION! THIS WILL RESET AND START FUEL-TRIMS AT ZERO!**



2. Loosen the clamp on the throttle body using 8mm nut driver.



3. With pliers, pull back the crank case line from the intake fitting.

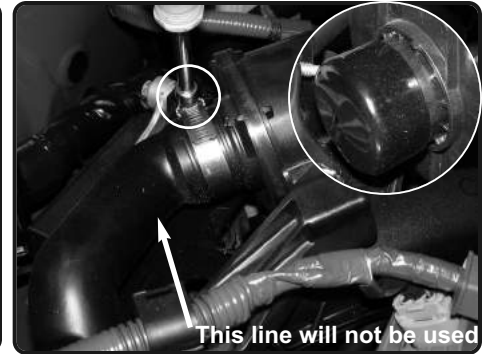

4. Loosen the clamp on the Sound Tube resonator. Loosen the clamp on the intake tube and remove the sound tube. This will no longer be used on the new Injen intake system. Use provided Vinyl cap and cap off sound tube.

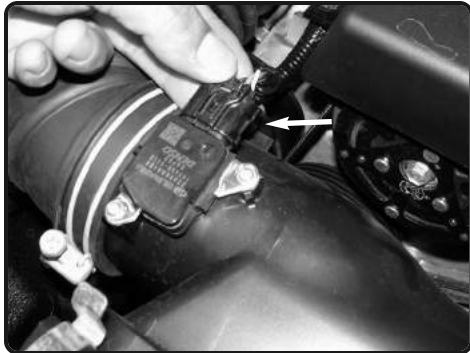

5. Disconnect MAF sensor harness and pull line away from air box.



6. Un-clip the upper part of the air box, remove the upper assembly including the intake tube from the vehicle.

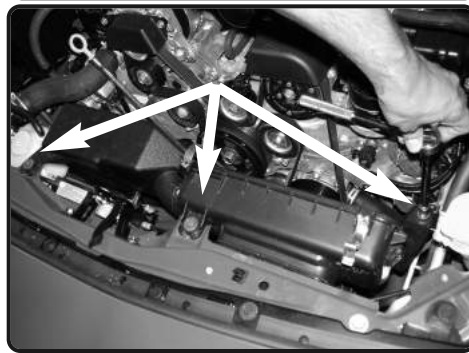

7. Loosen the 3 screws holding in the bottom half of the air box using 10mm socket and ratchet. Now lift up and remove the lower intake assembly from vehicle. Save for later install.

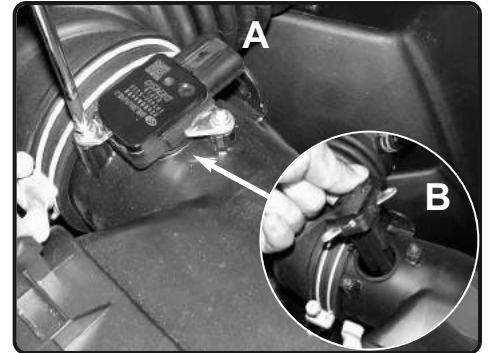

8. A) Loosen the 2 screws holding in the MAF sensor using the Phillips screwdriver. B) Remove the MAF sensor from the vehicle.



9. Carefully remove bumper cover. Remove the push-clips and 10mm screws on top and bottom and side and remove.



10. Remove the air box resonator by loosening the 2 bolts.

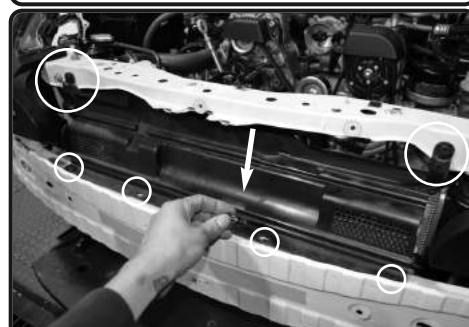

11. Remove the plastic splash guard from the front of vehicle, disconnect the push clips and remove.

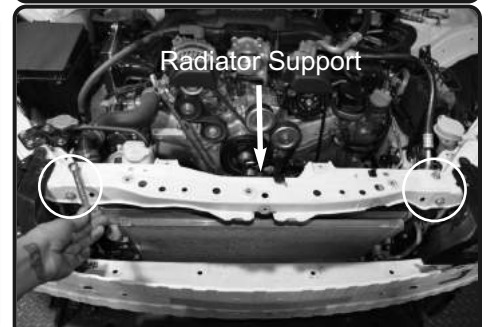

12. Loosen the 4 bolts on top of radiator support using 12mm socket or wrench. *This will be for installation of Ram Scoop.*

Instruction Manual P/N:EVO2000

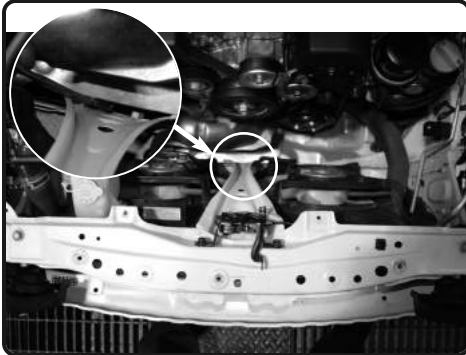

13. Locate the 2 remaining bolts on bottom of the radiator support in front of exhaust manifold loosen and remove.



14. Push back radiator support allowing for the install of the injen ram scoop.



15. Install the provided gasket to the ram scoop.



16. Install the ram scoop to the front of the vehicle between the bumper support and radiator.

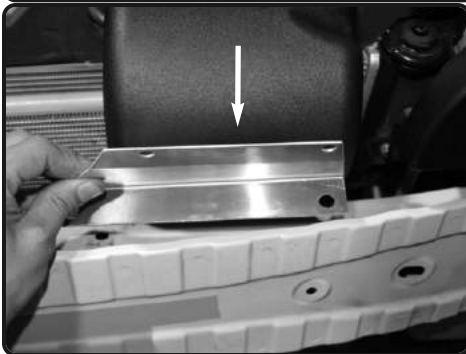

17. Install the ram scoop bracket to the ram scoop and the bumper support.

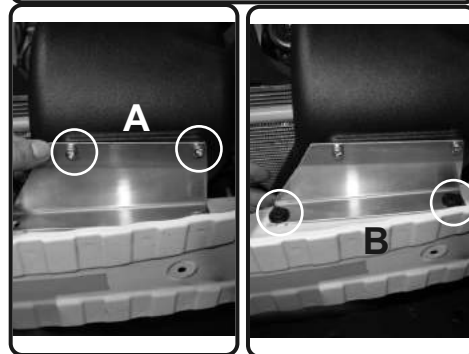

18. A) Use the provided M6 socket cap screws to secure the bracket to the scoop. B) Use the OEM plastic push clips to secure the bracket to the bumper support.



19. RE-install the radiator support and secure. Re-install the bolts and tighten.

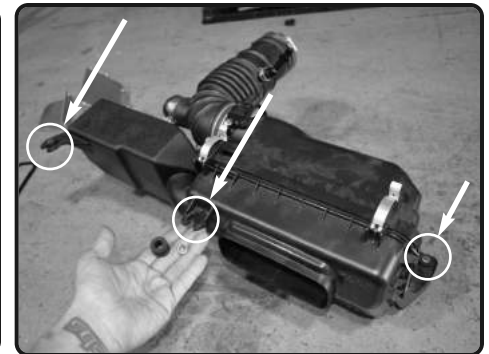

20. Remove the 3 grommets with crush spacer from stock air box. These will be used in new injen air box.



21. Remove the plastic 90 degree crank case elbow from stock intake tube.

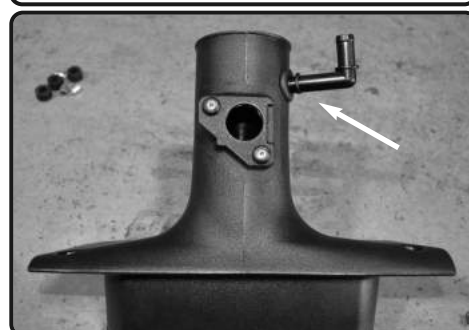

22. Install the provided grommet to the hole on intake plenum. Install the 90 degree plastic elbow long side first to the grommet and secure.



23. Remove the MAF sensor from the stock air box, install the MAF sensor into the new intake plenum.

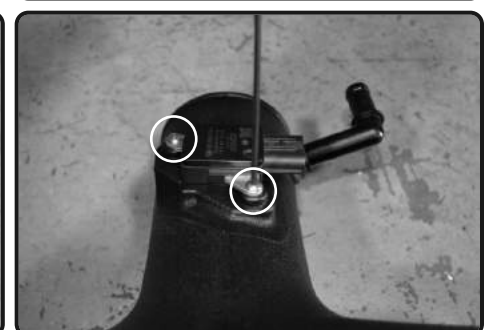

24. Secure the MAF sensor using provided M4 screws and tighten 2.5mm allen key.



25. Install the 3" hump hose with clamps provided to the intake plenum. Do not tighten.

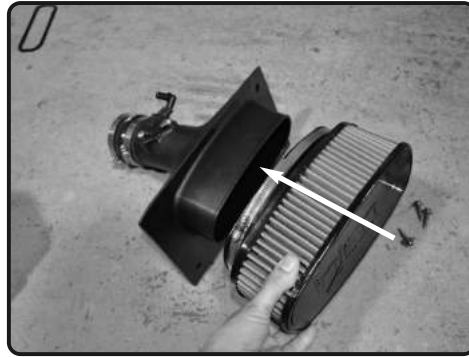

26. Install the filter to the intake plenum, secure and tighten using 8mm nut driver.



27. Install the grommet to the hole on the air box.



28. Attach the 3mm hose to the filter minder. Now install the hose through the grommet, secure the filter minder and make sure seats in grommet properly



29. Now attach the 3mm hose to the fitting on the filter.

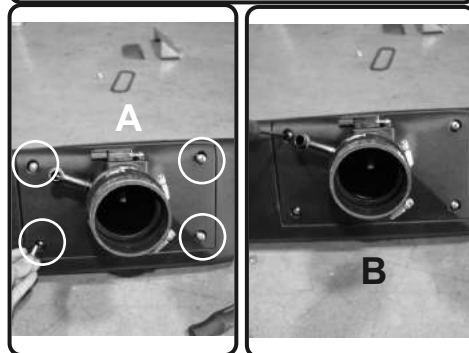

30. A) Install the plenum to the air box. Secure using phillips screws and rubberized washers. B) Secure and tighten using phillips screwdriver.

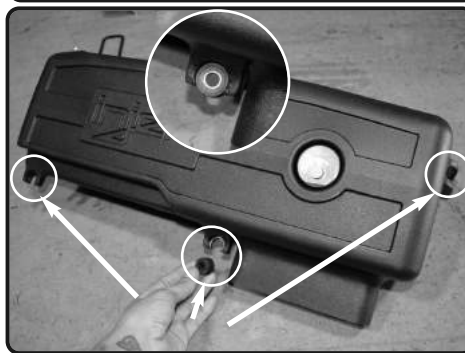

31. Now install the factory grommets with crush washer removed from the OEM air box (step 20)

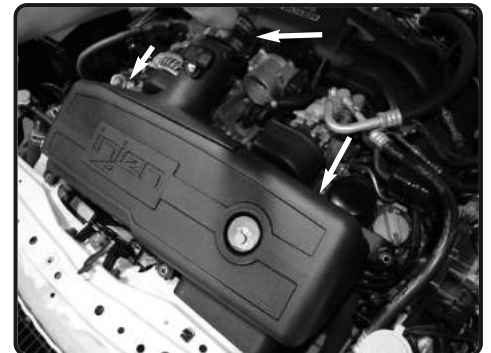

32. Push hump hose forward allowing for hose to slide back. Install the injen evolution intake assembly into vehicle.

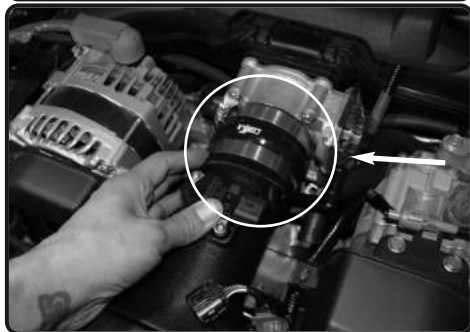

33. Position air box. Slide the hose on to the throttle body. Do not tighten .

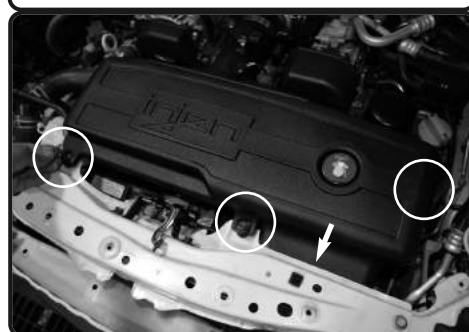

34. Make sure the injen box and the scoop are attached. Make sure the gasket is sandwiched between. Now secure the air box using the factory screws from step 7.

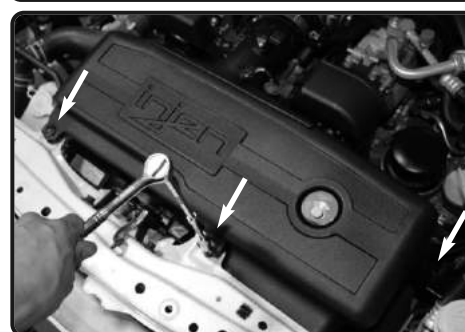

35. Secure and tighten all the screws using 10mm socket or wrench.



36. Now adjust the hump hose, secure and tighten the clamps using 8mm nut driver.

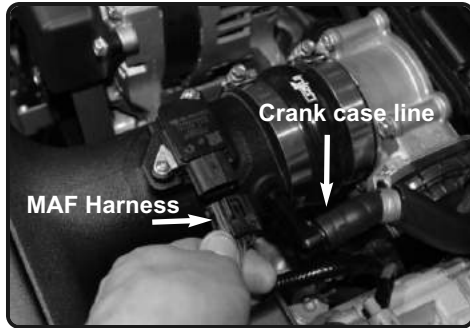

37. Secure and tighten all the screws using 10mm socket or wrench.



38. Secure the MAF sensor using provided M4 screws and tighten 2.5mm allen key.



39. *Optional Rain Guard for the front Ram Scoop sold Separately p/n:EVO20125*

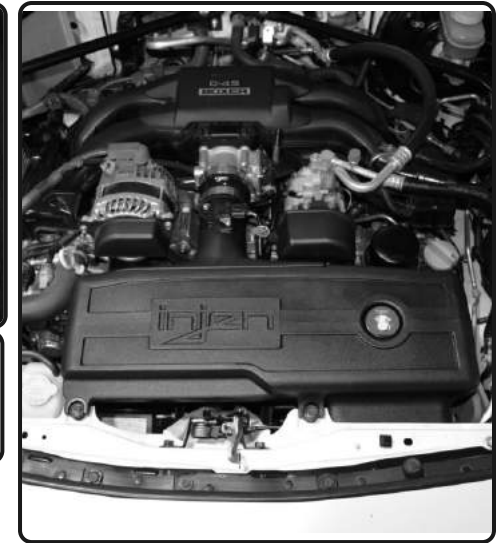

Congratulations! You have just completed the installation of this intake system. Periodically, check the alignment of the intake, normal wear and tear can cause nuts and bolts to come loose. Note: Check clearance and adjust if needed! Failure to check the alignment and adjust the intake can cause damage that will void the warranty. Injen Technology is not responsible for any damages caused by/from improper installation.

Test Drive:

1. With the transmission in neutral or park and the parking brake engaged, start the engine. Listen for air leaks or odd noises. If air leaks are detected, secure hoses and connections. For any odd noises, inspect entire system for cause and adjust intake as needed. The Injen intake will function identically to the factory system but will be louder and more powerful.
2. Perform a road test. Listen for odd noises or rattles and fix as necessary.
3. If there are no issues, continue to enjoy your added performance from the Injen performance Intake kit.
4. Injen Technology recommends you periodically check clearance and adjust if needed! Failure to check the alignment and adjust the intake can cause damage that will void the warranty. Injen Technology is not responsible for any damages caused by/from improper installation.

1. Upon completion of the installation, reconnect the negative battery terminal before you start the engine.
 2. Align the entire intake system for the best possible fit. Once the intake has been properly fitted continue to tighten all nuts, bolts and clamps.
 3. Periodically, recheck the alignment of the intake system and make sure there is proper clearance around and along the length of the intake. Failure to follow proper maintenance procedures may cause damage to the intake and will void the warranty.
 4. Start the engine and listen carefully for any odd noises, rattles and/or air leaks prior to taking it for a test drive. If any problems arise go back and check the vacuum lines, hoses and clamps that maybe causing leaks or rattles and correct the problem.
 5. Check the filter for excessive dirt build up. Clean or replace the filter with an original Injen filter (can be bought on-line at "injenonline.com").
- Congratulations! You have just completed the installation of the best intake system sold on the market. Enjoy the added power and performance of your new intake system.**